

SafeGuard ®

STAR

Student Transportation Add-On Restraint

Instruction Manual



STAR

- 25 - 65 lbs. (11.3 - 29.5 kg)
- 52 in. (132 cm) tall or less
- at least 1 year of age*

* See page 3 for details



STAR Special Needs

- 25 - 105 lbs. (11.3 - 47.5 kg)
- 52 in. (132 cm) tall or less
- at least 1 year of age*

* See page 3 for details

U.S. Patent Numbers: US 8,113,584; US 7,347,494; US 7,770,969



913439

Table Of Contents

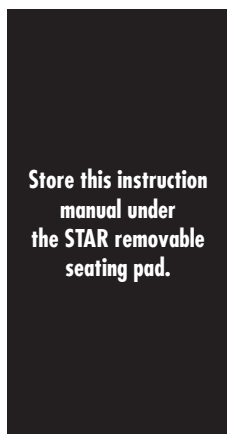

	Page
General Information	1
Registration Information.....	1
General Warnings	2
Features	2
Weight & Height Limitations.....	3
Installation.....	3
Securing Child	5
Chest Strap Option	7
Emergency Evacuation	7
STAR Special Needs Option.....	8
Care & Maintenance	11

General Information

The SafeGuard team truly cares about child passenger safety and is committed to providing innovative restraints that offer the utmost in safety and ease of use. While no restraint can prevent injury in every situation, proper installation and use of a restraint can substantially reduce a child’s risk of serious injury or death.

It is critical to read and understand these instructions and the vehicle manufacturer’s instruction BEFORE using this restraint. Failure to properly use this restraint may result in serious injury or death of the child being transported. If you have any questions after reviewing the instructions, please contact us at:

SafeGuard Customer Service: www.safeguardseat.com (or) 1-877-447-2305.

This restraint system conforms to all applicable Federal Motor Vehicle Safety Standards.

Registration Information

Please fill out the prepaid registration card attached to the restraint and mail it today or register online at the website listed below.

Restraints could be recalled for safety reasons. You must register this restraint to be reached in a recall.

Send your name, address, the restraint’s model number, manufacturing date and serial number to IMMI, 18881 IMMI Way, Westfield, IN 46074 or call 1-877-447-2305 or register online at www.safeguardseat.com/clients/product-registration/.

For recall information, call the U.S. Government’s Vehicle Safety Hotline at 1-888-327-4236 (TTY: 1-800-424-9153), or go to <http://www.safercar.gov>.

The restraint model number and manufacture date are located on a printed label sewn to the webbing above the seating platform.

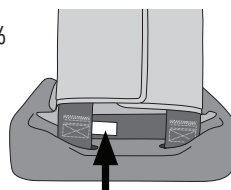

General Warnings

⚠ WARNINGS

FAILURE TO FOLLOW THESE WARNINGS CAN RESULT IN SERIOUS INJURY OR DEATH. PLEASE READ AND FOLLOW ALL INSTRUCTIONS CAREFULLY.

- THIS RESTRAINT MUST ONLY BE USED ON SCHOOL BUS SEATS. ENTIRE SEAT DIRECTLY BEHIND MUST BE UNOCCUPIED OR HAVE RESTRAINED OCCUPANTS.
- DO NOT USE THIS RESTRAINT UNTIL YOU READ AND UNDERSTAND THE INSTRUCTIONS IN THIS MANUAL.
- FOLLOW ALL INSTRUCTIONS ON THE RESTRAINT AND IN THIS MANUAL.
- DO NOT MODIFY THIS RESTRAINT OR USE ANY ACCESSORIES OR PARTS SUPPLIED BY OTHER MANUFACTURERS. USE ONLY SAFEGUARD REPLACEMENT PARTS.
- NEVER USE THE RESTRAINT SYSTEM IF IT IS DAMAGED OR MISSING PARTS. DO NOT USE A CUT, FRAYED OR DAMAGED HARNESS OR SEAT BELT.
- DO NOT USE BLEACH OR HARSH CLEANSERS ON SEAT CUSHIONS, WEBBING OR BUCKLES. NEVER LUBRICATE THE SEAT BELT BUCKLES.
- A CHILD RESTRAINT SHOULD BE PROPERLY SECURED EVEN WHEN UNOCCUPIED SINCE AN UNSECURED CHILD RESTRAINT MAY INJURE OTHER OCCUPANTS IN A CRASH.

Features

STAR

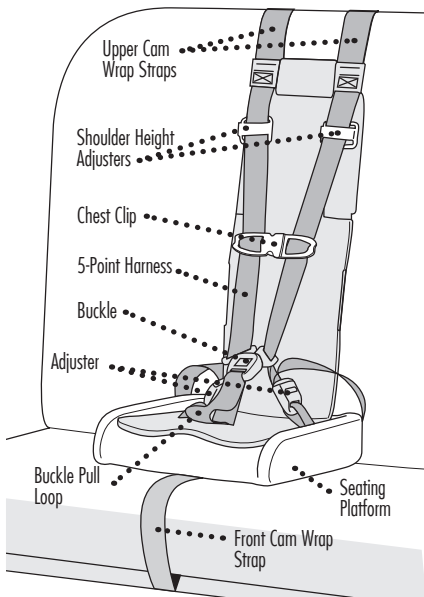

STAR Special Needs

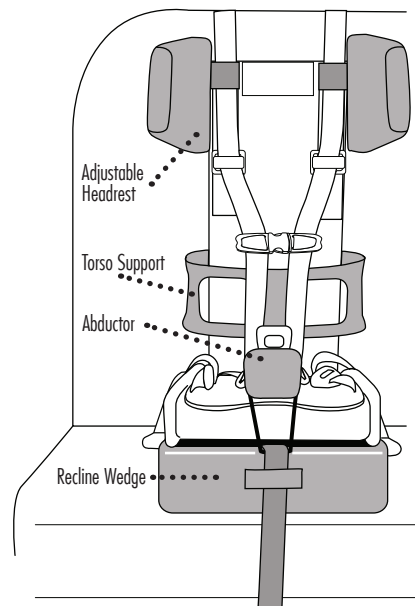

Weight & Height Limitations

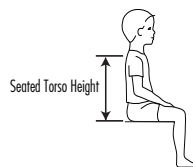

STAR

- 25 - 65 lbs. (11.3 - 29.5 kg)
- 52 in. (132 cm) tall or less
- at least 1 year of age*
- 20 in. (50 cm) or less seated torso height

STAR Special Needs

- 25 - 105 lbs. (11.3 - 47.5 kg)
- 52 in. (132 cm) tall or less
- at least 1 year of age*
- 20 in. (50 cm) or less seated torso height

* Caregivers should follow NHTSA best practice child car seat recommendation: Children under 1 should always ride in rear-facing car seats; and children 1 - 3 years of age (should) ride in rear-facing car seats as long as possible and until they reach the upper height or weight limit according to the manufacturers' instructions. **A child must be a minimum of 1 year of age and 25 lbs to use this restraint.**

Installation on the School Bus Seat

Note: For STAR Special Needs, refer to the installation instructions on pages 8-10 first.

Important Note: STAR may be secured to a standard 222 school bus seat unless your state code requires that the seat be FMVSS 210 reinforced. Check your state codes.

⚠ WARNING! DEATH or SERIOUS INJURY can occur:

- Follow all instructions on the child restraint and in this manual. Failure to follow the manufacturer's warnings for proper use of this child restraint system can result in serious injury or death.

1. Position the STAR restraint on the bus seat. Place the three upper cam wrap straps around the top of the school bus seat back. Insert the two lower cam wrap straps through the opening at the rear of the school bus seat cushion. **A**

Webbing should route in **FRONT** of the rear cross tube if possible (see inset).

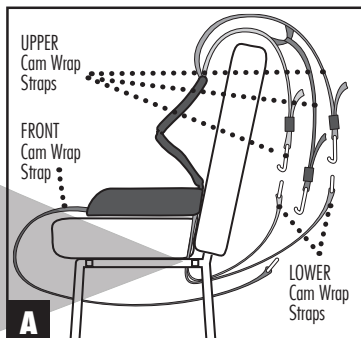
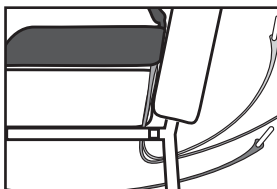

2. If the opening at the rear of the school bus seat cushion is blocked, lift the school bus seat cushion as shown in **B**. Thread the two lower cam wrap straps through the opening. Lower the seat cushion to its original position and lock into place. Be sure the lower cam wrap straps are not trapped within the seat cushion.

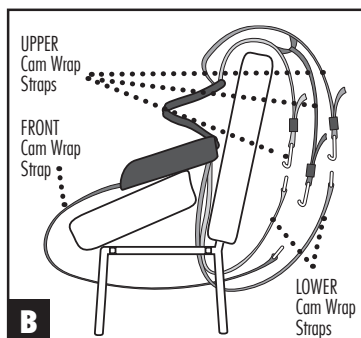

3. Connect the left upper cam wrap strap to the left lower cam wrap strap. Connect the right upper cam wrap strap to the right lower cam wrap strap. Pull adjuster straps to tighten both outside cam wrap straps. **C & D**

Important: Be sure to secure and tighten the two outer cam wrap straps before connecting the middle cam wrap strap. Proper tightening will compress the foam at the top of the school bus seat by approximately a half inch.

4. Connect the middle upper cam wrap strap to the front cam wrap strap. Pull adjuster strap to tighten. **E**

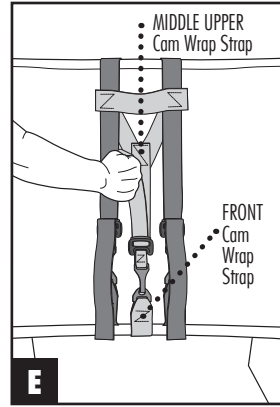
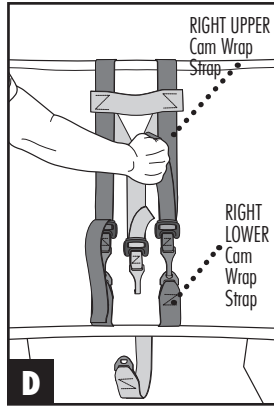
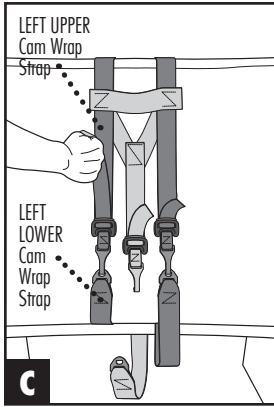

5. Verify the security of the restraint by moving the rear of the seating platform sideways. It should move less than an inch.

6. Once all straps are tight and secured, use the plastic keeper on each strap to secure the free ends of the three upper cam wrap straps. **F**

Important: Straps must appear as in **G** after installation is complete.

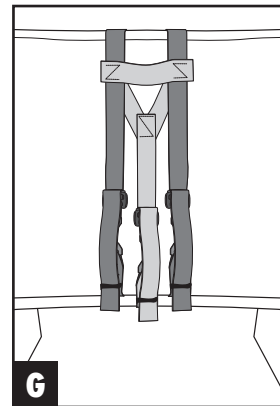
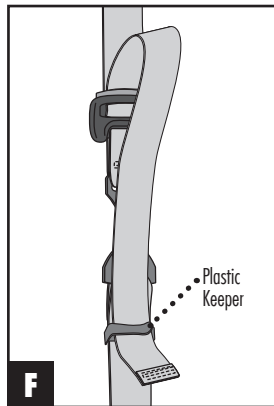

Securing the Child

⚠ WARNING! DEATH or SERIOUS INJURY can occur:

- Follow all instructions on the child restraint and in this manual. Failure to follow the manufacturer's warnings for proper use of this child restraint system can result in serious injury or death.
- Backpacks must be removed before using the STAR restraint.
- Snugly adjust the belts provided with this restraint around the occupant.

1. Prepare harness:

- Loosen harness: Push left harness adjuster button and pull up on left shoulder strap. **A** Repeat with right shoulder strap.
- Open chest clip and unbuckle harness.
- Lay buckle flat, toward front of restraint.

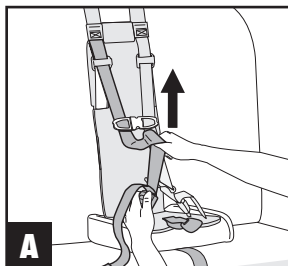

2. Place child in restraint: **B**

- Place child in restraint with child's back flat against the back of the restraint.
- Remove any twists from harness straps.
- Position harness shoulder straps over child's shoulders.

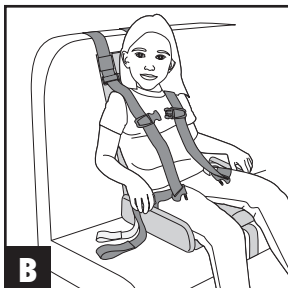

3. Buckle harness:

- Use buckle pull loop to pull buckle away from child.
- Make sure harness straps are not twisted.
- Insert buckle tongues into harness buckle. Listen for an audible click when each buckle tongue is fastened. **C**
- Check buckle connection is secure by pulling on shoulder straps.

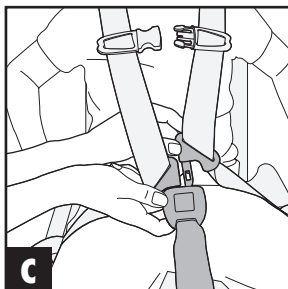

4. Tighten harness:

- Pull free end of harness strap, located on the outside of child's leg, until harness is snug around the child. **D**
- Repeat with second harness strap.
- A snug strap should not allow any slack. It lies in a relatively straight line without sagging. It does not press on the child's flesh or push the child's body into an unnatural position.
- Be sure the harness is snug and tight on both the thighs and chest before each use.

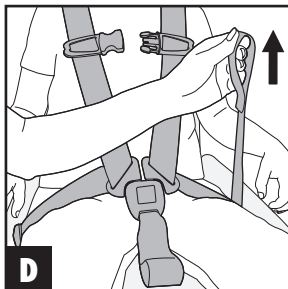

5. Fasten harness chest clip: E

- Fasten chest clip by pushing both sides together.
- Position chest clip at middle of child's chest, at armpit level.

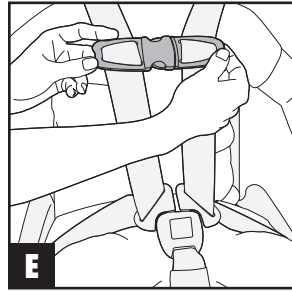

6. Adjust harness height:

- Position each yellow shoulder height adjuster at or just above child's shoulder. F

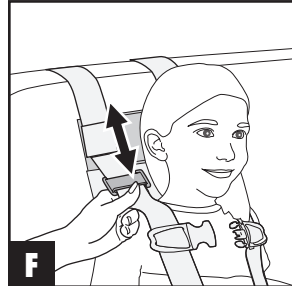

To remove child from the child restraint:

- Open chest clip by squeezing middle tabs and pulling apart. G
- Loosen harness: Pull shoulder strap up while pushing button on harness adjuster located on outside of child's leg. Repeat with second harness strap. H
- Use buckle pull loop to pull buckle and buckle pad away from child. Unbuckle harness buckle by pressing down on red release button. I
- Remove child.
- Rebuckle harness to prevent twisting of the straps.

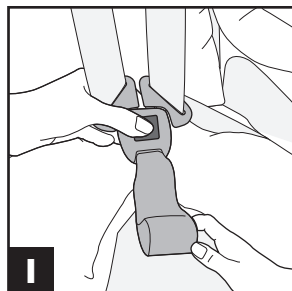
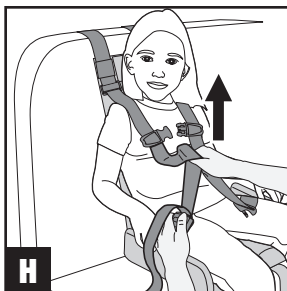
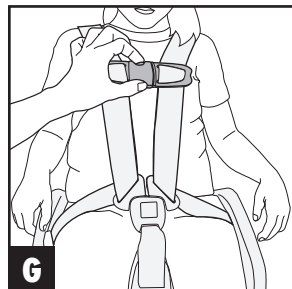

Chest Strap Option

For STAR

⚠ WARNING! DEATH or SERIOUS INJURY can occur:

- Orange chest strap is for positioning assistance only and is not a restraint device.
- Orange chest strap may not be substituted for shoulder straps or any other portion of STAR restraint.
- Orange chest strap should be used only in addition to the full harness.
- Orange chest strap must be placed under the shoulder straps.

The STAR chest strap is designed to provide positioning assistance for children with special needs.

Chest Strap Option Installation:

1. Position the optional orange chest strap around the child's chest. Proper position of orange chest strap is at the middle of child's chest, at armpit level. **A**
2. Fasten the orange chest strap buckle and adjust the strap snugly. A snug strap should not allow any slack. It lies in a relatively straight line without sagging. It does not press on the child's flesh or push the child's body into an unnatural position. **A**
3. Properly secure the child in the STAR restraint system. **B**

Important: Orange chest strap must be placed under the shoulder straps.

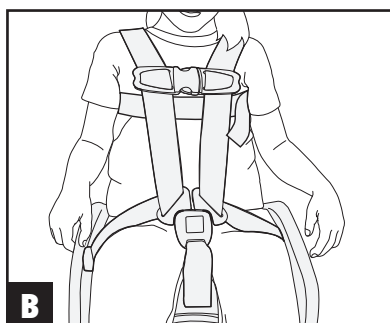
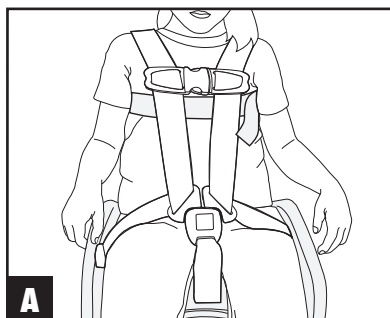

Emergency Evacuation

For STAR

The STAR restraint system is designed to remain operational after most crash situations. In the event of a crash or an event that necessitates an emergency evacuation, follow this procedure.

1. Open chest clip by squeezing middle tabs and pulling apart.
2. Unbuckle harness buckle by pressing down on red release button.
3. If not possible to perform Steps 1 and 2, use a belt cutter to cut shoulder webs below chest clip. **A** If optional orange chest strap is being used, cut chest strap on right side of child. **A**
4. Remove child.

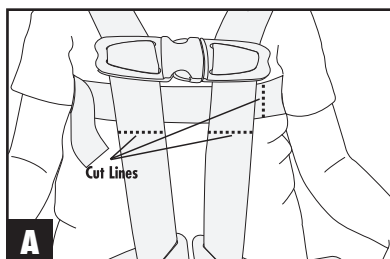

STAR Special Needs

Weight Range: 25 - 105 lbs. (11.3 - 47.5 kg)

Standing Height: 52 in. (132 cm) or less

Seated Torso Height: 20 in. (50 cm) or less

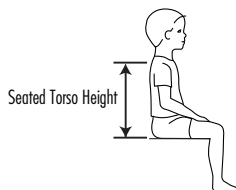

Restraint Features

The STAR Special Needs restraint is equipped with additional features as shown below to provide support for children with special health care needs.

The STAR Special Needs restraint features may be used in any combination based on the child's needs.

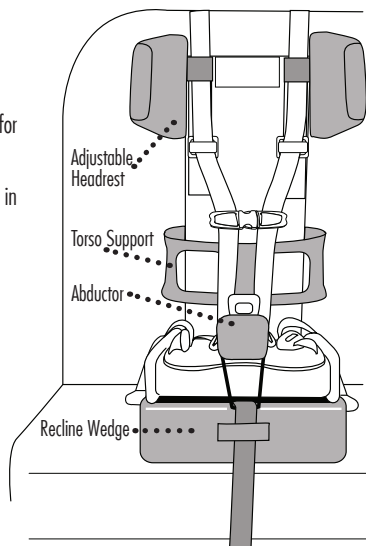

Recline Wedge

The recline wedge is used to provide additional lower torso support as needed.

Recline Wedge Installation:

1. Verify adhesive-backed velcro strips are on bottom of seating platform. If missing replace with new strips.
2. Position the recline wedge on the bus seat with the tallest side facing the front of the bus seat. Be sure to align the hook and loop fasteners on the bottom of the seating platform and the top of the recline wedge.
3. Thread the front black cam wrap strap through the webbing sewn onto the front of the recline wedge. **A**
4. Follow the STAR installation instructions on page 3 to complete the installation of the restraint to the bus seat.

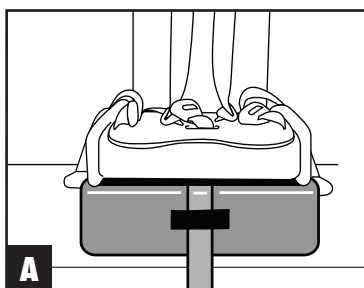

Installation Tip: When using both the abductor and the recline wedge, first thread the front black cam wrap strap through the elastic strap sewn onto the front of the abductor then through the webbing sewn onto the front of the recline wedge.

STAR Special Needs continued

Headrest

The width and height of the headrest are both adjustable to provide additional support for the child's head.

Headrest Installation:

1. Adjust headrest width if necessary. (See instructions below.)
2. Orient the STAR Special Needs restraint so the back of the shoulder harness faces up. **A**
3. Position the headrest such that the I-shaped openings are centered on the exposed black webbing. **A**
4. Grasp the black webbing and pull it through the first I-shaped opening. Repeat with the second I-shaped opening. **B**

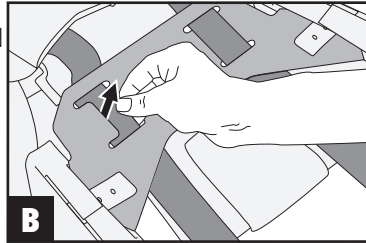
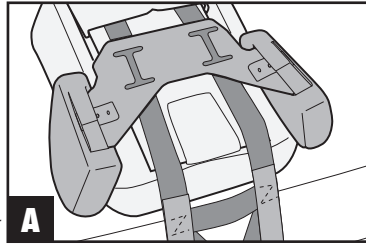

Headrest Width Adjustment:

1. Remove the headrest from the STAR Special Needs restraint.
2. Open the two fabric tabs on the back of the headrest cover.
3. Detach the vinyl tab from the attach tab.
4. Detach the elastic strap from the attach tab.
5. Remove the plastic headrest panel from the headrest cover and foam.
6. Select Slot 1 for a wide width headrest or Slot 2 for a narrow width headrest. **C**
7. Insert the plastic headrest panel into the selected slot.
8. Reattach the elastic strap to the attach tab. **D**
9. Reattach the vinyl tab using Hole 1 for wide width or Hole 2 for narrow width. **D**
10. Close the two fabric headrest cover tabs.
11. Repeat steps 2-10 for the opposite side of the headrest.

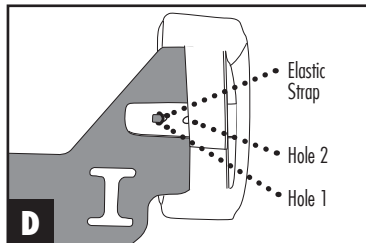
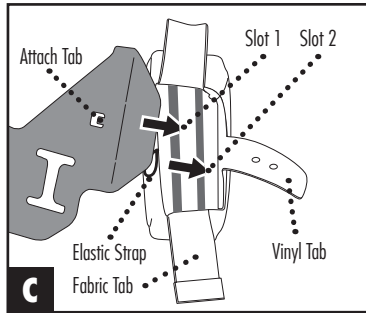

Headrest Height Adjustment:

After the STAR Special Needs restraint is installed on the bus seat, grasp both sides of the headrest and slide it up or down to provide proper support for the child's head. **E**

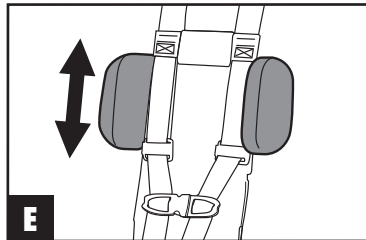

STAR Special Needs continued

Abductor

The abductor is used to provide additional leg support as needed.

Abductor Installation:

1. Unbuckle the harness buckle.
2. Position the abductor on the restraint in front of the buckle with the widest portion of the abductor facing the front of the bus seat.
3. Thread the buckle through the webbing sewn onto the back of the abductor. **A**
4. Thread the front black cam wrap strap through the elastic strap sewn onto the front of the abductor. **B**
5. Follow the STAR installation instructions on page 3 to complete the installation of the restraint to the bus seat.

Installation Tip: When using both the abductor and the recline wedge, first thread the front black cam wrap strap through the elastic strap sewn onto the front of the abductor then through the webbing sewn onto the front of the recline wedge.

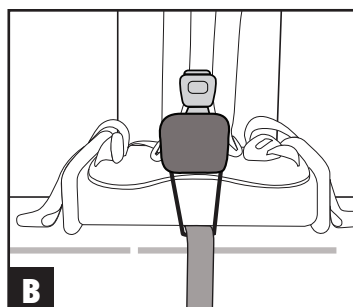
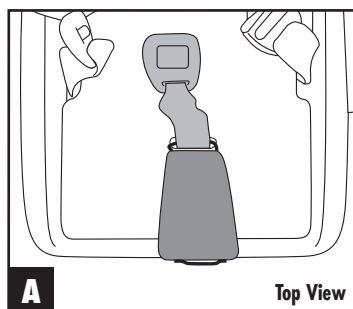

Torso Support

⚠ WARNING! DEATH or SERIOUS INJURY can occur:

- Torso support is for positioning assistance only and is not a restraint device.
- Torso support may not be substituted for shoulder straps or any other portion of STAR restraint
- Torso support should be used only in addition to the full harness
- Torso support must be placed under the shoulder straps

The torso support is used to provide additional support to the upper torso as needed.

Torso Support Installation:

1. Follow the STAR installation instructions on page 3 to complete the installation of the restraint to the bus seat.
2. Open the torso support and thread it between the restraint and the bus seat. **A**
3. Position and secure the torso support around the child using the hook and loop fastener.
4. Position and secure the child in the restraint following the STAR instructions. Be sure the harness is snug and tight on both the thighs and chest before each use.

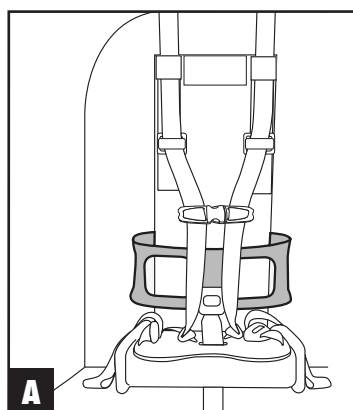

Important: Torso support must be placed under shoulder straps.

Care and Maintenance

- Cleaning care and maintenance protocols of the STAR are the responsibility of the owner of the STAR.
- Seating pad and base: Use a damp sponge, towel or cloth with mild soap* and lukewarm water. Gently scrub the material. Apply a separate wet towel to wipe off any soap* residue. Allow 10 minutes to air dry.
- Seating Pad: The pad can be removed for machine washing in cold water on gentle cycle and tumbled dry on low heat. DO NOT use chlorine bleach or dry clean the pad. The seating pad is connected to the base with the use of hook and loop fasteners. To remove, pull up on the pad to remove from the base and disconnect the hook and loop fasteners on the back of the pad in two places. If the seating pad becomes overly soiled or damaged, a replacement pad can be ordered from your original place of purchase or by calling 877-447-2305.
- Seat Belt Webbing: Wipe with a damp sponge, towel, or cloth using mild soap* solution and lukewarm water. Allow 15-20 minutes to air dry.
- Buckle and buckle components: Wipe clean with a damp sponge, towel, or cloth with lukewarm water only. Never use cleaning products on buckles or buckle components. These cleaning products can cause harm to the mechanisms.
- Never use lubricating agents to clean because they will compromise the integrity of the seat belt buckle and webbing retractor.

**Approved mild soaps for warm water solution are Ivory, Dreft, Woolite, and Dawn dishwashing soaps.*

Care and Maintenance continued

STAR Restraint Replacement

The STAR restraint system is considered to have a finite life and must be frequently inspected and replaced as needed. The default service life of a STAR restraint is 6 years from the date of manufacture. You may also use the date of invoice by following the directions below. Use of the STAR must be discontinued six years after the date of invoice or the date of manufacture if the invoice information label is not completed. The date of manufacture can be found on the back of the lower portion of the cam wrap strap where it connects to the seat base (**Figure 1**).

To activate service life from date of invoice, locate the information label on the side of the STAR base. You must enter Invoice Date, Invoice number, and name of the seller of your STAR. All information must be entered for this to be valid. Remove the backing from the label clear cover and seal the label with the information you have entered (**Figure 2**).

The STAR and its components must be inspected frequently (per instructions on the following page). If you have any doubts about the condition or function of the restraint, REPLACE IT, even if it is less than 6 years from the date of service expiration.

If any component or part of the STAR restraint requires replacement (with the exception of the replaceable pad), the entire system must be replaced.

Figure 1

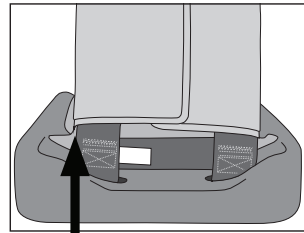

Date of Manufacture

Figure 2

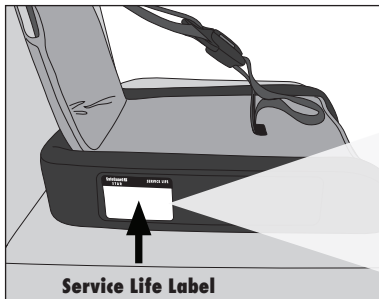

Service Life Label

SafeGuard STAR	SERVICE LIFE
	To be filled in by end user
Frequent inspection of STAR is required. Replace as needed. Unit expires 6 years from date of invoice or date of manufacturer if label is incomplete.	Invoice Date
	Invoice Number
	Distributor Name

Label must be filled out completely.

Care and Maintenance continued

STAR In a School Bus Crash

If a school bus is involved in a moderate or severe crash, the entire STAR restraint must be replaced regardless if the STAR was occupied for use at the time of the crash. Reference the NHTSA Position Paper **“Re-Use of Child Restraint Systems In School Buses After Minor Crashes”** for more information on this matter. This document can be found on the NHTSA.gov website.

STAR Restraint Inspection

1. Inspect harness webbing on entire system for cuts, fraying, or extreme or unusual wear. Most common areas of belt wear include the buckle/latch area and any place where the restraint makes contact with the vehicle seat.
Corrective action – Replace entire STAR restraint.
2. Inspect latch and buckle for proper operation by inserting the latch into the buckle. Latch must insert smoothly, and you must hear an audible click. Verify proper latching by tugging on the belt. Latch must not be worn, deformed or corroded. Buckle must not be damaged, cracked or broken.
Corrective action – Replace entire STAR restraint.
3. Inspect the seat belt height adjuster for damage. Move adjuster up and down. It must move freely and should not be damaged, cracked or broken.
Corrective action – Replace entire STAR restraint.
4. Inspect dual cam wrap system for cuts, fraying, or extreme or unusual wear.
Corrective action – Replace entire STAR restraint.
5. Inspect chest clips for damage and operation. Chest clip halves should not be damaged, cracked or broken. Clips should engage and disengage smoothly with each other. Move clip halves up and down. They must move freely.
Corrective action – Replace entire STAR restraint.

Accessory - Connector Strap

Allows the positioning of three standard STAR restraints on a 39” school bus seat.

Federal Safety Standards

The SafeGuard STAR restraint is certified to applicable U.S. Federal Motor Vehicle Safety Standard FMVSS 213 and 302.





SafeGuard ®

safeguardseat.com

18881 IMMI Way | Westfield, IN 46074