

IMMI ®









The Most Trusted Leader in Safety Worldwide



imminet.com



TABLE OF CONTENTS

Global Excellence	3	
Core Safety Components	4	
Product Development and Quality	5	
Testing	6	
Buckles	7	
IMMI120 Buckle	10	
LATCH Attachments	13	
Slack Indicators	19	
Harness Chest Clips	20	
T-Bars, Splitter Plates, Slides	21	
Adjusters	29	
Mid-Belt Adjusters	31	
Webbing	33	
Counterfeit Alert	44	



Global Excellence

We are Bringing Safety to People® every day around the world. When it comes to the youngest among us, we believe protection begins on day one.

Leading the Way

3 IMMI is the pioneer in child seat safety. We have designed and manufactured child safety products used by parents all over the world. Our passion to keep children safer while on the road inspired IMMI products like the 5-point harness system, the 1Adjust®, Mini-Connector, and MiniLATCH, which are used by leading child seat manufacturers globally. So the next time you secure your child into a child seat, know that IMMI is holding on tight to what matters most.

IMMI has over 60 years of experience and leadership providing the most innovative and dependable safety restraint systems. We are excited to offer a complete product line that serves customers in every part of the world.



Core Safety Components

For decades, IMMI has worked with car seat manufacturers to design innovative, **easy-to-use** harnesses and LATCH attachment systems that give parents the confidence that the child seat they've purchased meets or exceeds the highest standards in safety.

Our advanced restraint systems and safety components are engineered to make car seats less complicated for parents to use.

Leading car seat manufacturers choose IMMI safety products because they improve their NHTSA (National Highway Traffic Safety Administration) ease of use ratings. Ratings improve when the child is easily secured in the harness, the seat is easily connected to the vehicle, and the instructions are clearly labeled and accessible.



All IMMI products for Europe and Asia are ECE R44/04, R129, and GB27887 certified and meet or exceed standard safety requirements.

Product Development and Quality

IMMI offers the most trusted quality and advanced engineering to help child seating manufacturers develop innovative systems that bring the best in car seat technology to today's parents.

The industry's finest engineers at IMMI work together with OEM engineers to assist with conceptual designs to develop advanced restraint systems that meet ease of use requirements, and to conduct testing to prove the performance of their products.

IMMI Provides:

5

- Complete system and/or component level testing capabilities on-site at IMMI with quick turnaround on test reports
- Applied mechanics: Nonlinear crash simulations using LS-Dyna
- CAD mechanical engineering software including Pro E, Ideas, UG
- Skilled engineers and in-house certified child passenger safety technicians
- In-house industrial design staff to assist with conceptual design for customers
- Facilities offering complete prototype build with rapid prototyping capabilities
- Meets ISO 14001 and TS-6949 quality certifications



Visit capetesting.com to see what it means to be
"CAPE Tested"



Testing Services

IMMI is the home of an award winning, one-of-a-kind crash-test facility, CAPE® (Center for Advanced Product Evaluation), which brings together advanced technology and specialized engineering expertise to provide customers with analytical information to support their most complex decisions. CAPE has conducted more safety tests on child restraints than any other test facility in the world.

Testing Services for Child Seat Manufacturers:

- Development testing
- Durability testing
- Sled testing/motion analysis
- Child ATDs including:
 - P 0, CAMH, CAMI-11, P 3/4, SA103C, P 3, CRABI2,*
 - HIII10C, VIP6C, HIII6C, P 6, P 10, CRABI8, SA106C,*
 - P 1-1/2, HIII3C*
- Confidential testing
- Testing to ECE R-44, R129, AS1754, FMVSS 213, and CMVSS 213
- Vehicle side impact testing per FMVSS 214
- In-vehicle rollover testing



dual-tongue BUCKLES

IMMI 5-point harness systems come in multiple configurations and are designed to meet all applicable worldwide safety standards including FMVSS 213, CMVSS 213, ECE R-44, R129, GB27887 and AS1754.

IMMI child seat buckles offer the latest in buckle technology and are designed to withstand the forces imposed by today's child car seat.

The following abbreviations are listed near the product descriptions and refer to the country specifications met. Specifications will vary by product.

- FMVSS 213 | US (United States)
- ECE R-44, R129 | EU (Europe)
- AS1754 | AU (Australia)
- CMVSS 213 | CA (Canada)
- GB27887 | CN (China)

7

Infant/child buckle
30° tongue
US/CA



A91131A

Grey

A91131B

Black

dual-tongue
BUCKLES



Child buckle
45° overmold slot tongue
US/CA



A91133B





dual-tongue
BUCKLES

Child buckle
45° overmold slot wide tongue
US/CA



A93997B

9

Child Buckle
45° overmold slot eject tongue
US/AU



A110316



INTRODUCING

The IMMI120 Buckle Family

When it comes to engineering and design, the IMMI120 buckle is the gold standard, bringing together the best parts of automotive technology with child safety products. IMMI's rigorous testing goes above and beyond to provide a premier buckle that offers customizable options. The IMMI120 also adds longevity and ease of use with ergonomic touchpoints. Magnetic tongues to help caregivers quickly secure the buckle's tongues, while a green indicator ensures the buckle is latched properly.



group 0/0+
BUCKLES

IMMI120z **IN DEVELOPMENT**

Plastic buckle for 3-point seat belt
Central push button system
Group 0/0+
EU/US/CN



A116820

Black

Options:

5-pt

Switch



group 1
BUCKLES



IMMI120
5-Point Buckle
EU/CH



FAMILY OFFERING

A112796-00	A113588-00*	A117017*
SLIM	CHOICES	CUSTOM
Minimal size. Maximum strength.	Customer branded. Upgraded features. Magnetic tongues Latched Indicator Electric switch Custom Badge Custom colors	Our Strength. Your Skin.
Good <i>Best buckle on market and "basic"</i>	Better <i>Options</i>	Best <i>Custom features, designs, etc.</i>

* Contact us for ordering information

Asia: Joe Xue jxue@imminet.com

Europe: Valeria Calosso vcalosso@imminet.com



latch

ATTACHMENTS

Combining strength and user-friendliness, the IMMI line of **LATCH attachments** makes car seat installation and removal easy.

IMMI offers a range of snap hook styles for use in LATCH systems.

The top tether slack indicator provides immediate feedback to the user regarding tether tension.

LOWER LATCH ATTACHMENTS

Mini-Connectors fasten to the vehicle's lower LATCH anchors in seconds with an audible click and are released easily with the push of a button. Mini-Connectors reduce misuse and help manufacturers achieve top NHTSA Ease of Use ratings.

13

Non-handed Mini-Connector

US/CA



A90705

latch

ATTACHMENTS



Left-handed Mini-Connector
US/AU/CA



A91137MB

14

Right-handed Mini-Connector
US/AU/CA



A91136MB



latch

ATTACHMENTS

Mini-Connector with LATCH
indicator

US/CA/AU



A94249B

15

ISOFIX Connector

IN DEVELOPMENT

EU/CH/US



latch
ATTACHMENTS



Snap Hook
US/EU



62916

16

Wide Slot Snap Hook
US/EU



15968



latch

ATTACHMENTS

Narrow Slot Snap Hook

US/EU/CA



915018

17

Snap Hook Keeper (AS 1754)

AU



62938

latch

ATTACHMENTS



Snap Hook (Canadian)

CA



62951

18

Snap Hook/Adjuster Combo

US



62955



slack

INDICATORS

Indicating Tilt Lock

38 mm

EU/CN



A111257



harness
CHEST CLIP



Two-piece Harness Chest Clip
(Can be customized with logos)

US/CA



62946AB

20

Infant Chest Clip
(Can be customized with logos)

US/CA



917275AB



t-bars, splitter plates &
SLIDES

Splitter Plate Single Slot
US/EU/AU/CA

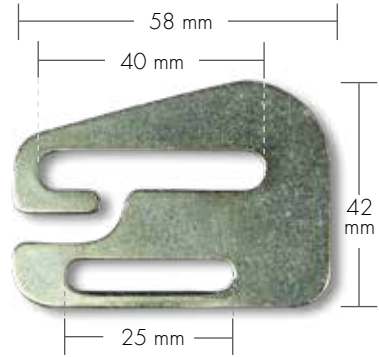

52073

21

T-Bar 72 mm Wide
US/EU/AU/CA



52061

t-bars, splitter plates &
SLIDES



T-Bar 100 mm Wide
US/EU/AU/CA

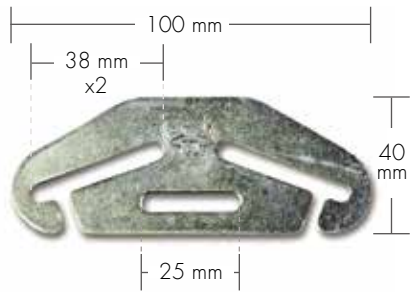

52028

22

T-Bar 100 mm Wide
US/EU/AU/CA

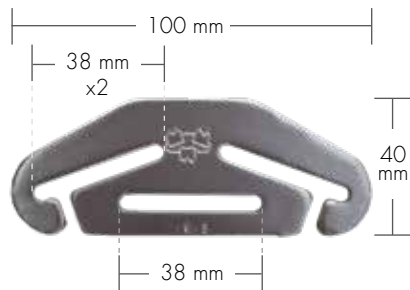

52043



t-bars, splitter plates &
SLIDES

T-Bar 100.1 mm Wide
US/EU/AU/CA

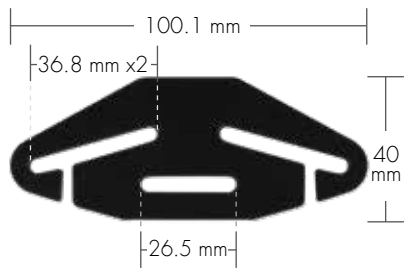

927671

23

T-Bar 70 mm Wide
US/EU/AU/CA



914689

t-bars, splitter plates &
SLIDES



T-Bar 66 mm Wide
EU

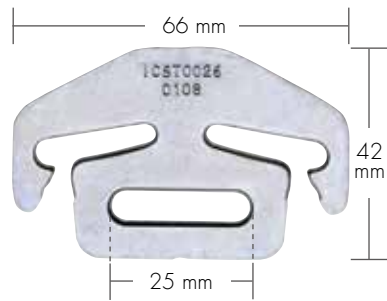

ICST0026





t-bars, splitter plates &
SLIDES

3-Bar Slide
US/EU/AU/CA

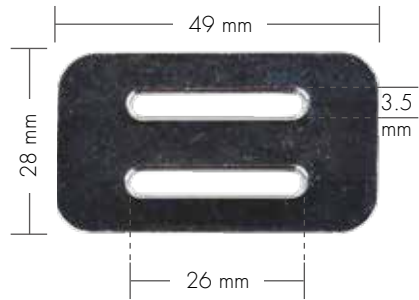

927672

25

3-Bar Slide
US/EU/AU/CA



927673

t-bars, splitter plates &
SLIDES



3-Bar Slide
Infant, Low Weight Harness
US/EU/AU/CA

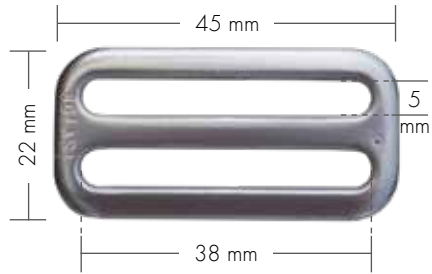

10285

26

3-Bar Slide
Low Weight Harness
US/EU/AU/CA

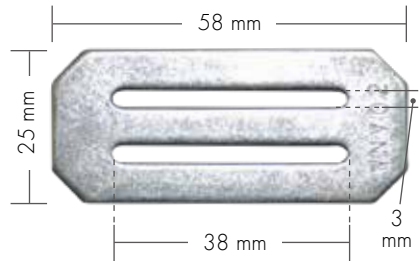

15245



t-bars, splitter plates &
SLIDES

3-Bar Slide
High Weight Harness
US/EU/AU/CA

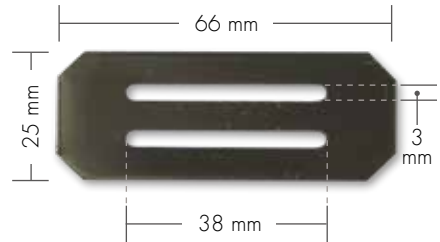

15186

27

3-Bar Slide
High Weight Harness
US/EU/AU/CA



915224

t-bars, splitter plates &
SLIDES



3-Bar Slide
Tether, High Weight Harness
US/EU/AU/CA

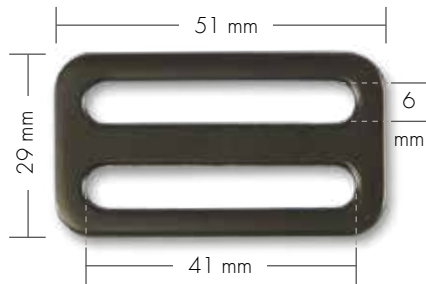

15152

28

3-Bar Slide
Tether, High Weight Harness
US/EU/AU/CA

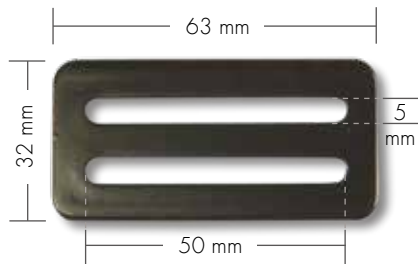

15158



ADJUSTERS

25 mm 2-Pin Adjuster
with web guide

US/EU/AU/CA/CN



A110251

29

25 mm Standard A-Lok®

US/EU/AU/CA/CN



A38298

ADJUSTERS



25 mm Bent Tab Push Cam

US/EU/AU/CA/CN



A111625 46°

A115209 47°

For additional options, contact IMMI

30

Plastic Cam A-Lok®

IN DEVELOPMENT

US/EU/AU/CA/CN



Base design: Black

Advanced design: Custom



mid-belt
ADJUSTERS

LATCH Adjuster
38 mm Slot
US/EU/AU/CA



A38279B

31

LATCH Adjuster
25 mm Slot
US/EU/AU/CA



A38325B

mid-belt
ADJUSTERS



Harness Adjuster
38 mm Slot
Plastic Button
US/EU/AU/CA



A38212B

32



WEBBING



25 mm 2 Panel

Material: Polyester
Tensile: 12.4 kN min (2788 lbs)
Elongation: 11.5% max at
5.6 kN (1250 lbs)



US/EU/CA/CN

11445	Black	11446	Tan
11444	Med. Slate Grey	917090	Fossil

25 mm 3 Panel

Material: Polyester
Tensile: 15.5 kN min (3485 lbs)
Elongation: 10% max at
5.6 kN (1250 lbs)



US/EU/CA/CN

911945	Black
911946	Med. Slate Grey

WEBBING



25 mm Lanyard Web

Material: Polypropylene
Tensile: 0.89 kN min (200 lbs)
Elongation: N/A



US/EU/CA/CN

912816	Black
912817	Orange

34

38 mm Cobblestone

Material: Polyester
Tensile: 15.0 kN min (3372 lbs)
Elongation: 6.5+/-2% at
5.56 kN (1250 lbs)



US/EU/CA/CN

20062	Black	11455	Tan
11454	Med. Slate Grey	917091	Fossil

WEBBING



38 mm 7 Uneven Panel

Material: Polyester
Tensile: 19.6 kN min (4400 lbs)
Elongation: 12+/-2% at
8.0 kN (1800 lbs)



US/EU/CA/CN

11315	Black	20056	Tan
20057	Med. Slate Grey		

35

38 mm 8 Panel

Material: Polyester
Tensile: 11.12 kN min (2500 lbs)
Elongation: 8+/-3% at
3.11 kN (700 lbs)

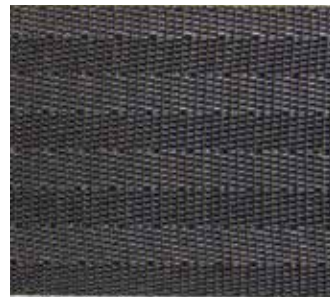

US/EU/CA/CN

11464	Black	11478	Lt. Tan
11465	Med. Slate Grey	11479	Orange
11481	Lt. Grey		

WEBBING



38 mm 9 Panel

Material: Polyester
Tensile: 16 kN min (3600 lbs)
Elongation: 16+/-3% at
5.56 kN (1250 lbs)



US/EU/CA/CN

11460	Black	11486	Lt. Grey
11461	Med. Slate Grey	11463	Tan

36

38 mm Diamond Weave

Material: Polyester
Tensile: 15 kN min (3372 lbs)
Elongation: 6.5+/-2% at
5.56 kN (1250 lbs)



US/EU/CA/CN

921054	Black
--------	-------

WEBBING



38 mm 6 Panel

Material: Polyester
Tensile: 13 kN min (2922 lbs)
Elongation: 10-15% at
7.0 kN (1574 lbs)



AU

921372 Black
926998 Med. Slate Grey

37

38 mm 6 Panel

Material: Polyester
Tensile: 16 kN min (3600 lbs)
Elongation: 9-17% at
10.0 kN (2248 lbs)

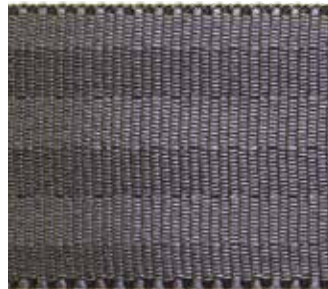

AU

924366 Black

WEBBING



25 mm 2 Panel

Material: Polyester
Tensile: 11 kN min (2472 lbs)
Elongation: 6-14% at
6.0 kN (1349 lbs)



AU

921373 Black
927154 Med. Slate Grey

38

26 mm 4 Panel

Material: Polyester
Tensile: ≥ 9 kN
Elongation: under 5 kN: 10-13%

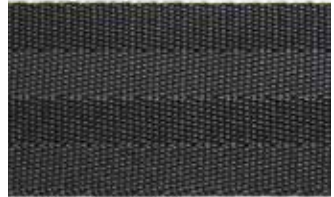

EU/CN

Black

WEBBING



26 mm 3 Panel

Material: Polyester
Tensile: ≥ 9 kN
Elongation: under 5 kN: 7 - 9%



EU/CN

Dark Grey

39

26 mm 4 Panel

Material: Polyester
Tensile: ≥ 8.6 kN
Elongation: under 5 kN: 10-13%

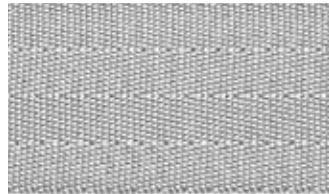

EU/CN

Lt. Grey

WEBBING



26 mm 4 Panel

Material: Polyester
Tensile: ≥ 14 kN
Elongation: under 3 kN: 4-5%

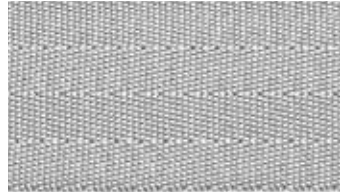

EU/CN

Lt. Grey

40

34 mm 4 Panel

Material: Polyester
Tensile: ≥ 9 kN
Elongation: under 5 kN: 13%

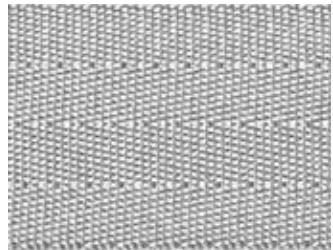

EU/CN

Lt. Grey

WEBBING



30 mm 4 Panel

Material: Polyester
Tensile: ≥ 9 kN
Elongation: under 5 kN: 10-13%

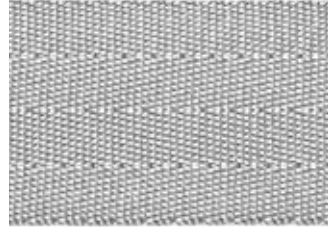

EU/CN

Lt. Grey

41

38 mm 9 Panel

Material: Polyester
Tensile: ≥ 13 kN
Elongation: under 10 kN: 8-10%



EU/CN

Black

WEBBING



38 mm 9 Panel

Material: Polyester

Tensile: ≥ 13 kN

Elongation: under 10 kN: 8-10%



EU/CN

Dark Grey

42

38 mm 9 Panel

Material: Polyester

Tensile: ≥ 15 kN

Elongation: under 5 kN: 6%

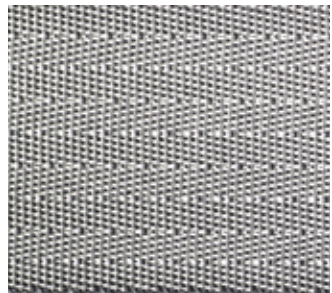

EU/CN

Lt. Grey

WEBBING



26 mm 4 Panel

Material: Polyester
Tensile: ≥ 14 kN
Elongation: under 5 kN: 7-9%

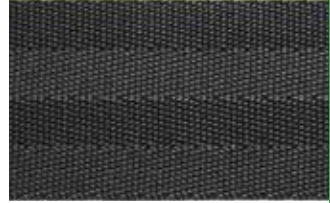

US

Black

43

38 mm 9 Panel

Material: Polyester
Tensile: ≥ 14 kN
Elongation: under 10 kN: 10-12%



US

Black

IMPORTANT!

Counterfeit Products

Counterfeit products can kill.

As the world's leading manufacturer and innovator of buckles, restraints, and other child safety products for car seats, we are challenged in trying to prevent fake products, sold under our brand, from entering the market. IMMI has a combined history of providing the highest quality safety products in the car seat industry that protects literally tens of millions of children every day. Our products are vigorously tested, compliant with all regulatory standards, and are built with integrity.

We are the experts in our field; however, the downside to having the most trusted brand name in the industry is that counterfeiters increasingly attempt to copy our products with sub-standard materials and workmanship. These fake products could lead to serious injuries, and even death. Your best protection against counterfeited safety products is to only purchase from an account manager, or representative of IMMI.

If you believe that you have seen counterfeit IMMI products, please contact us immediately: info@imminet.com

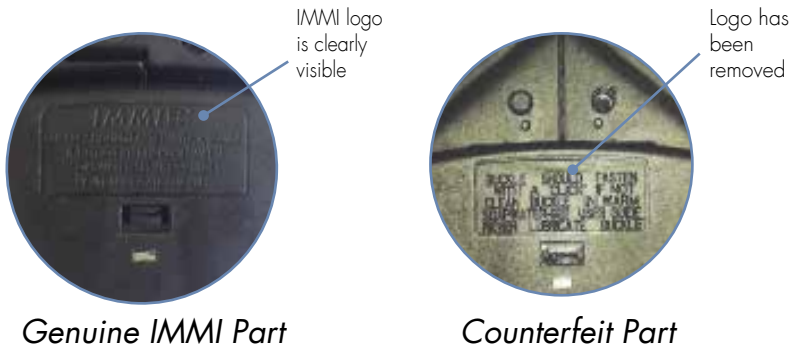



The Most Trusted Leader in Safety Worldwide

